

Article number: 01010471
 Description: Retaining ring A 30 DIN 471
 Stainless 411
 Note: Fitted with ZGA pilers

Measures

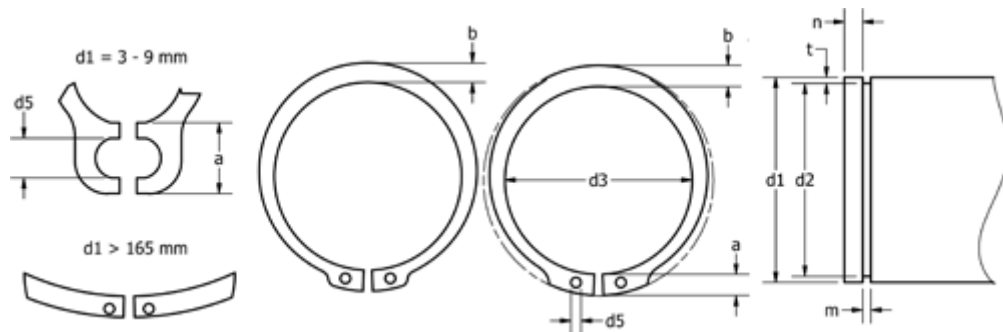

a max	= 5.0	FN kN	= 10.7	s	= 1.50
AN mm ²	= 64.0	FRg kN	= 7.65	t	= 0.70
b	= 3.5	FR kN	= 32.10	tol	= -0.21
d1	= 30	g	= 1.5	tol	= -0.06
d2	= 28.6	K kN-mm	= 64.20	tol	= +0,21-0,42
d3	= 27.9	m min	= 1.60	Tong	= ZGA-2
d5 min	= 2.0	n abl x 1000	= 19.0	Weight kg/1000	= 3.320
Description	= A30	Nominal drive	= 2.1		